

GE
Lighting

Tetra[®] Contour & Contour LS LED Lighting System

NEON replacement that fits your business

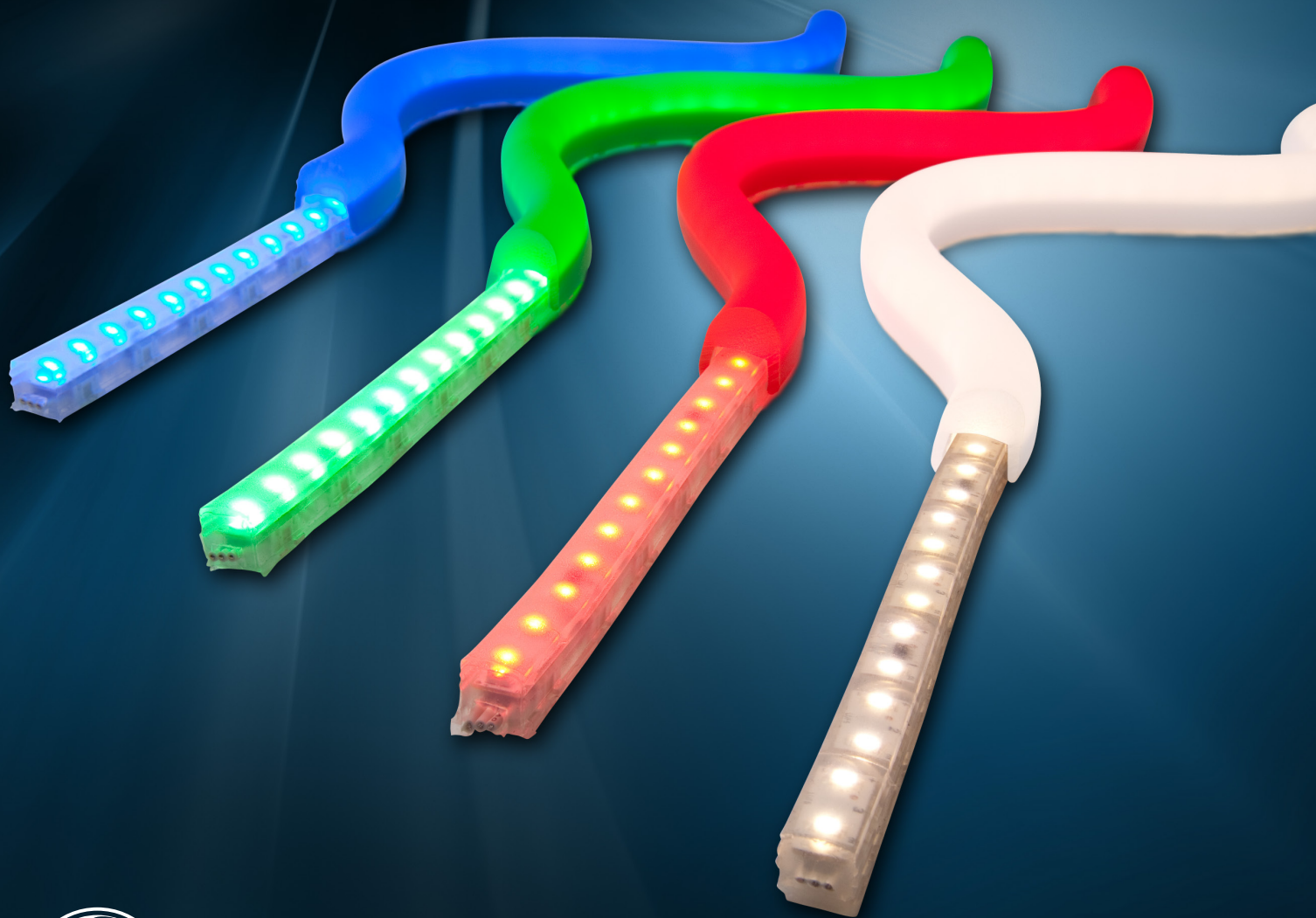

imagination at work

Tetra® Contour & Contour LS

Complete NEON replacement system

Tetra Contour combines a flexible LED light engine with a rigid, optically diffuse extruded-plastic light guide that can be heated and formed to fit a wide variety of designs and applications. **Tetra Contour LS** (linear series) is the unbendable companion product used for creating linear border lighting sections. Working together, these products comprise a complete LED system that provides the classic appearance of neon and complements the unique design of any building.

Labor Saving Installation

Tetra Contour installation is quick and easy using low-profile mounting clips. It provides a bright, uniform appearance, seamless illumination and a wide 330° of light output. **Tetra Contour LS** comes pre-assembled and features a plug & play design that saves on labor and installation costs. For each 8-foot (2.44m) length, simply screw in light guide mounting clips, clip Tetra Contour LS into place, use quick connectors to plug in next section, and you're done.

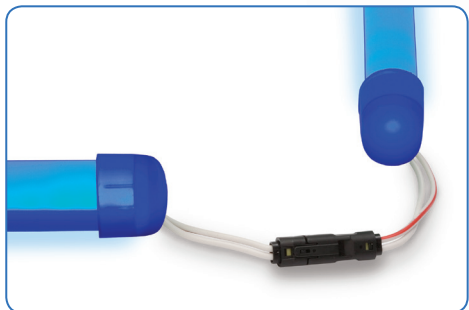

Contour LS installation is simplified with plug-&-play quick connectors



Range of Colors

With several brilliant colors of LED light engine and several vibrant light guides to choose from, designers can mix-n-match components to easily create customized looks.

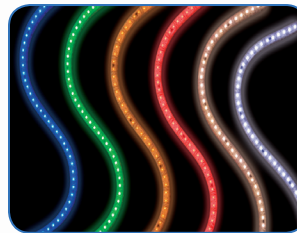

Tetra Contour light engine



Tetra Contour light guide

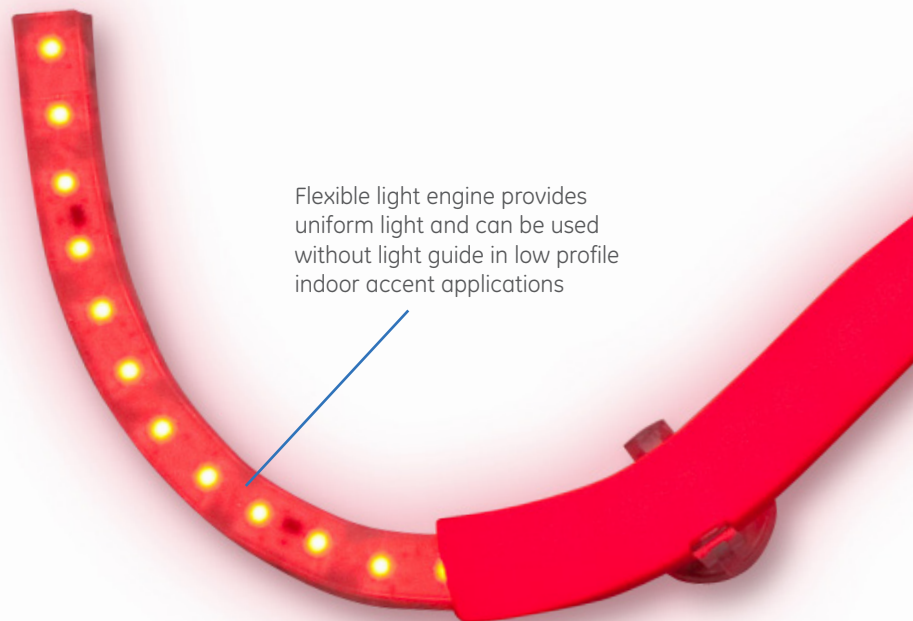

Flexible light engine provides uniform light and can be used without light guide in low profile indoor accent applications

Vastly Superior Loading

Versus our previous products, improved **Tetra Contour** features **103% greater loading**, and new **Tetra Contour LS** delivers **137% greater loading**—so more feet of product can be run off each power supply than ever before—providing significant savings on material and labor costs.

Durable Robust System

Designed using GE Six Sigma quality standards, the **Tetra Contour** LED lighting system has a long life that delivers up to five years of continuous 24/7 use. Impact resistant design helps eliminate excess shipping, installation and maintenance costs due to breakage. It withstands harsh weather conditions, vibration and stress, and is backed by our 5-year Limited Warranty.

Tested for Reliability

To ensure every **Tetra Contour** LED lighting system will perform brilliantly for years, we not only test for reliability, we also validate the robustness of our products. Rather than rely solely on the test data from LED suppliers, we test the LED, sub-system and complete Tetra system at our in-house and independent laboratories around the world. Validation of our designs, components, products and processes include high-temperature, high-humidity and accelerated life testing.

Designed with Environmental Responsibility in Mind

This environmentally responsible LED lighting system complies with RoHS standards. **Tetra Contour** contains no lead, mercury or glass, so handling and disposal are less of a concern.

Diffused light guide gives the appearance of neon

Tetra® Contour

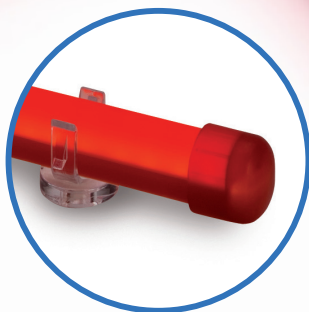

End cap provides finished appearance

Can be mounted using light guide mounting clips or standard neon hardware

Seamless designs can be created using the light guide connector

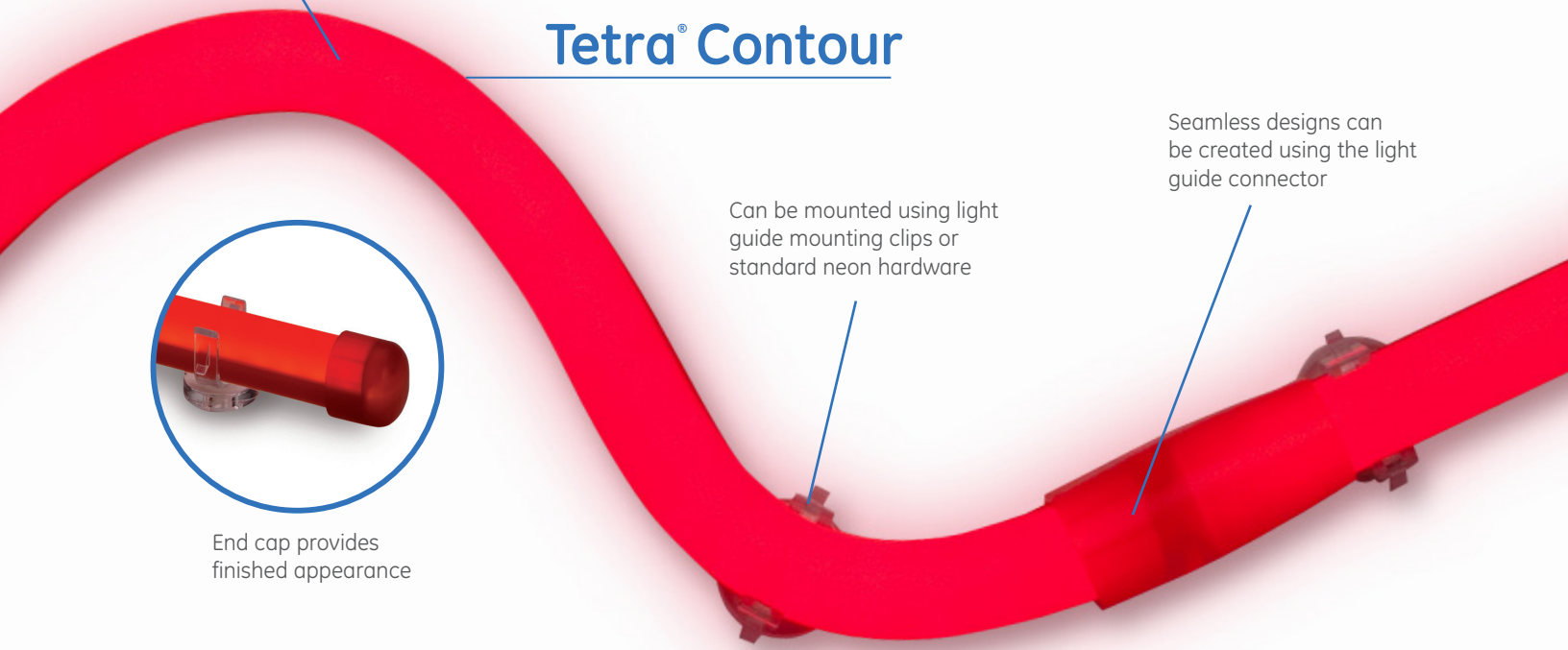

Product Dimensions

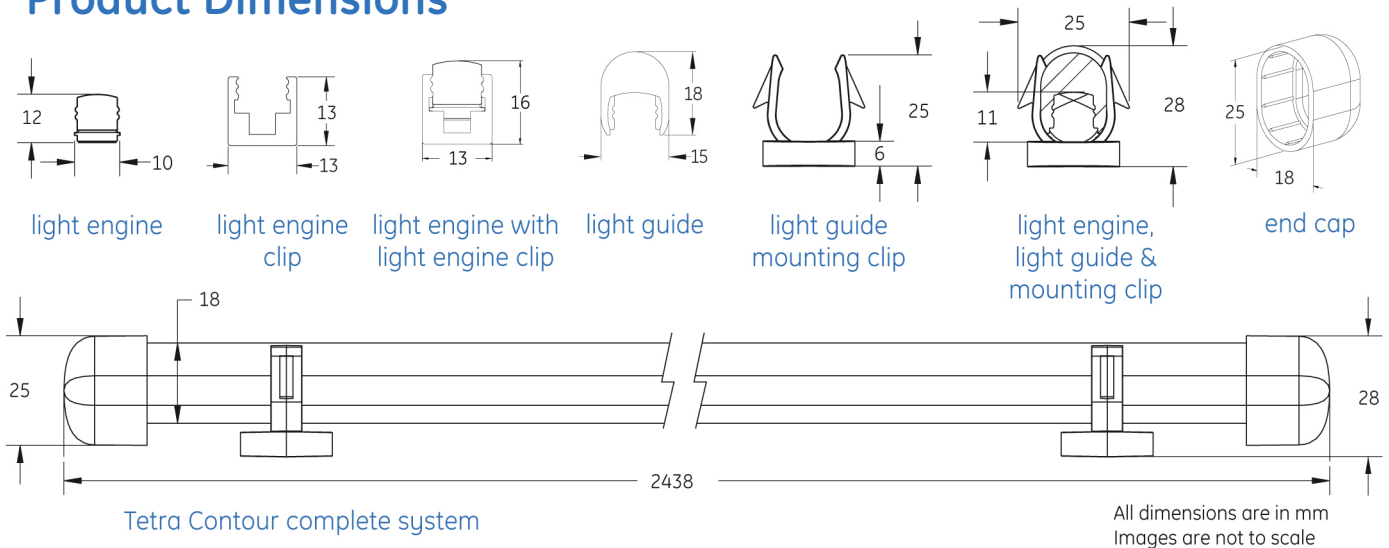

Additional Extensions

Additional extension sections and accessory pieces are also available. **Tetra Contour LS** extensions come in 16 inch (406mm) lengths and feature a compact cutting resolution to aid in custom fitting. Accessories are available in straight connectors and a variety of 90-degree corners to create seamless designs



Tetra[®] Contour LS

Diffused light gives the appearance of 15mm neon

Contour LS comes in pre-assembled 8-foot (2.44m) lengths



Simple installation using light engine mounting clip in low-profile designs

Tetra® Contour & Contour LS

SKU	Description	Color	Quantity	Additional Information
GEXNBL-1	Tetra® Contour Blue LED Light Engine	Blue	12/Box	Unit Length 8 ft (2.44m)
GEXNGL-1	Tetra® Contour Green LED Light Engine	Green	12/Box	Unit Length 8 ft (2.44m)
GEXNYG-1	Tetra® Contour Amber LED Light Engine	Amber	12/Box	Unit Length 8 ft (2.44m)
GEXNRC-1	Tetra® Contour Red-Orange LED Light Engine	Red-Orange	12/Box	Unit Length 8 ft (2.44m)
GEXNRD-1	Tetra® Contour Red LED Light Engine	Red	12/Box	Unit Length 8 ft (2.44m)
GEXN65-1	Tetra® Contour White (6500K) LED Light Engine	White	12/Box	Unit Length 8 ft (2.44m)
GEXN32-1	Tetra® Contour Warm White (3200K) LED Light Engine	Warm White	12/Box	Unit Length 8 ft (2.44m)
GEXNLBL-1	Tetra® Contour LS Blue Light Engine and Blue Light Guide	Blue	12/Box	Unit Length 8 ft (2.44m)
GEXNLGL-1	Tetra® Contour LS Green Light Engine and Green Light Guide	Green	12/Box	Unit Length 8 ft (2.44m)
GEXNLRD-1	Tetra® Contour LS Red Light Engine and Red Light Guide	Red	12/Box	Unit Length 8 ft (2.44m)
GEXNL65-1	Tetra® Contour LS White Light Engine (6500K) and White Light Guide	White	12/Box	Unit Length 8 ft (2.44m)
GEXNL32-1	Tetra® Contour LS Warm White (3200K) LED Light Engine	Warm White	12/Box	Unit Length 8 ft (2.44m)

Technical Specifications

Specification Item	Wavelength Color Temp	Typical Brightness lumens/ft (light engine)	LEDs/Module	Energy Consumption (Strip/ft)	Energy Consumption (System/ft)	Power Supply Loading (ft/100W)	Viewing Angle (light engine/with light guide)
GEXNBL-1	467nm	30	42	1.52	1.79	59	115/330
GEXNGL-1	532nm	120	42	1.52	1.79	59	115/330
GEXNYG-1	589nm	60	42	2.27	2.67	40	115/330
GEXNRC-1	618nm	85	42	2.27	2.67	40	115/330
GEXNRD-1	625nm	55	42	1.52	1.79	59	115/330
GEXN65-1	6500K	140	48	3.17	3.73	29	115/330
GEXN32-1	3200K	130	48	3.17	3.73	29	115/330
GEXNLBL-1	467nm	30	21	1.73	2.03	52	115/330
GEXNLGL-1	532nm	120	21	1.73	2.03	52	115/330
GEXNLRD-1	625nm	55	21	1.30	1.53	69	115/330
GEXNL65-1	6500K	140	24	3.17	3.73	29	115/330
GEXNL32-1	3200K	130	24	3.17	3.73	29	115/330

Specification Item	Specification																									
Cutting Resolution	On Contour ONLY cut on wire between every module or the location showing "CUT HERE ONLY" on module.																									
Power Supply	GEPS24-20 Input: 90-264VAC; Output: 24VDC GEPS24D-80U Input: 90-305VAC; Output: 24VDC GEPS24W-80 Input: 90-264VAC; Output: 24VDC GEPS24-100-NA Input: 108-305VAC; Output: 24VDC GEPS24-100-GL Input: 108-305VAC; Output: 24VDC GEPS24-180U Input: 90-305VAC; Output: 24VDC																									
Maximum Supply Wire Limits	<table border="1"> <thead> <tr> <th></th> <th>18 AWG/0.82 mm² Supply Wire</th> <th>16 AWG/1.31 mm² Supply Wire</th> <th>14 AWG/2.08 mm² Supply Wire</th> <th>12 AWG/3.31 mm² Supply Wire</th> </tr> </thead> <tbody> <tr> <td>20W Power Supply</td> <td>20 ft./6.1 m</td> <td>-</td> <td>-</td> <td>-</td> </tr> <tr> <td>80W Power Supply</td> <td>20 ft./6.1 m</td> <td>30 ft./9.1 m</td> <td>50 ft./15.2 m</td> <td>86 ft./26.1 m</td> </tr> <tr> <td>100W Power Supply</td> <td>20 ft./6.1 m</td> <td>30 ft./9.1 m</td> <td>50 ft./15.2 m</td> <td>86 ft./26.1 m</td> </tr> <tr> <td>180W Power Supply</td> <td>20 ft./6.1 m</td> <td>30 ft./9.1 m</td> <td>50 ft./15.2 m</td> <td>86 ft./26.1 m</td> </tr> </tbody> </table>		18 AWG/0.82 mm ² Supply Wire	16 AWG/1.31 mm ² Supply Wire	14 AWG/2.08 mm ² Supply Wire	12 AWG/3.31 mm ² Supply Wire	20W Power Supply	20 ft./6.1 m	-	-	-	80W Power Supply	20 ft./6.1 m	30 ft./9.1 m	50 ft./15.2 m	86 ft./26.1 m	100W Power Supply	20 ft./6.1 m	30 ft./9.1 m	50 ft./15.2 m	86 ft./26.1 m	180W Power Supply	20 ft./6.1 m	30 ft./9.1 m	50 ft./15.2 m	86 ft./26.1 m
	18 AWG/0.82 mm ² Supply Wire	16 AWG/1.31 mm ² Supply Wire	14 AWG/2.08 mm ² Supply Wire	12 AWG/3.31 mm ² Supply Wire																						
20W Power Supply	20 ft./6.1 m	-	-	-																						
80W Power Supply	20 ft./6.1 m	30 ft./9.1 m	50 ft./15.2 m	86 ft./26.1 m																						
100W Power Supply	20 ft./6.1 m	30 ft./9.1 m	50 ft./15.2 m	86 ft./26.1 m																						
180W Power Supply	20 ft./6.1 m	30 ft./9.1 m	50 ft./15.2 m	86 ft./26.1 m																						
Operating Environment	-40 °C to +60 °C																									
Module Dimensions (h x l x w)	Light engine: 12mm x 406mm x 10.1mm Light engine with light guide: 28mm x 2440mm x 25mm																									
Sign Dimensions	N/A																									
Warranty	GE offers a limited system warranty of up to five (5) years																									
System Certifications	UL Recognized #E219167, UL Classified #E229508, CE, C-tick, RoHS, Light engine IP54 rated: Dry or damp location rated Light engine and Light Guide IP66 rated: Dry, damp or wet location rated																									



Tetra® Contour & Contour LS | Components

SKU	Description	Color	Quantity	Additional Information
GERDXNLG15	Tetra Contour Light Guide	Red	12/box	Unit Length: 8 ft. (2.44m)
GEPOXNLG15	Tetra Contour Light Guide	Orange	12/box	Unit Length: 8 ft. (2.44m)
GEYAXNLG15	Tetra Contour Light Guide	Yellow	12/box	Unit Length: 8 ft. (2.44m)
GEGLXNLG15	Tetra Contour Light Guide	Green	12/box	Unit Length: 8 ft. (2.44m)
GEBLXNLG15	Tetra Contour Light Guide	Blue	12/box	Unit Length: 8 ft. (2.44m)
GEXNLG15	Tetra Contour Light Guide	White	12/box	Unit Length: 8 ft. (2.44m)

Accessories

SKU	Description	Color	Quantity	Additional Information
GEPS24-20	Power Supply: Input: 90-264VAC, Output: 24VDC/20W		10 power supplies	
GEPS24-80	Power Supply: Input: 108-264VAC, Output: 24VDC/80W		10 power supplies	
GEPS24-100U	Power Supply: Input: 108-305VAC, Output: 24VDC/100W		10 power supplies	
GEPS24-180	Power Supply: Input: 90-305VAC, Output: 24VDC/180W		8 power supplies	
9409	18 AWG (0.82mm ²) Supply Wire		500 ft. (152.40 m) per spool	2 wire
GEXNWB2	Weather Box		20/bag	White, Paintable Surface
GEXNBA	Tetra Contour Silicone Bend-Aid (Reusable)		12/bag	Unit Length: 16 in. (406mm)
GEXNMC15	Tetra Contour Light Guide Mounting Clip 50/bag			
GEXNMCAC	Tetra Contour Light Engine Mounting Clip		20/bag	White, Paintable Surface
191600041	22-14 AWG Twist-on Wire Connector (0.82-2.08 mm ²)		500/bag	
ULA Approved	Blue 300V rated 22-14 AWG Connector			
GERDXNLGEC15	Tetra Contour Light Guide End Cap	Red	20/bag	
GERDXNLGC15	Tetra Contour Light Guide Connector	Red	20/bag	
GERDXNLGI15	Tetra Contour Light Guide 90° Inside Corner	Red	20/bag	
GERDXNLGO15	Tetra Contour Light Guide 90° Outside Corner	Red	20/bag	
GERDXNLGP15	Tetra Contour Light Guide 90° Planar Corner	Red	20/bag	
GEPOXNLGC15	Tetra Contour Light Guide Connector	Orange	20/bag	
GEPOXNLGEC15	Tetra Contour Light Guide End Cap	Orange	20/bag	
GEPOXNLGI15	Tetra Contour Light Guide 90° Inside Corner	Orange	20/bag	
GEPOXNLGO15	Tetra Contour Light Guide 90° Outside Corner	Orange	20/bag	
GEPOXNLGP15	Tetra Contour Light Guide 90° Planar Corner	Orange	20/bag	
GEYAXNLGC15	Tetra Contour Light Guide Connector	Yellow	20/bag	
GEYAXNLGEC15	Tetra Contour Light Guide End Cap	Yellow	20/bag	
GEYAXNLGI15	Tetra Contour Light Guide 90° Inside Corner	Yellow	20/bag	
GEYAXNLGO15	Tetra Contour Light Guide 90° Outside Corner	Yellow	20/bag	
GEYAXNLGP15	Tetra Contour Light Guide 90° Planar Corner	Yellow	20/bag	
GEGLXNLGEC15	Tetra Contour Light Guide End Cap	Green	20/bag	
GECLXNLGC15	Tetra Contour Light Guide Connector	Green	20/bag	
GEGLXNLGI15	Tetra Contour Light Guide 90° Inside Corner	Green	20/bag	
GEGLXNLGO15	Tetra Contour Light Guide 90° Outside Corner	Green	20/bag	
GEGLXNLGP15	Tetra Contour Light Guide 90° Planar Corner	Green	20/bag	
GEBLXNLGEC15	Tetra Contour Light Guide End Cap	Blue	20/bag	
GEBLXNLGC15	Tetra Contour Light Guide Connector	Blue	20/bag	
GEBLXNLGI15	Tetra Contour Light Guide 90° Inside Corner	Blue	20/bag	
GEBLXNLGO15	Tetra Contour Light Guide 90° Outside Corner	Blue	20/bag	
GEBLXNLGP15	Tetra Contour Light Guide 90° Planar Corner	Blue	20/bag	
GEXNLGEC15	Tetra Contour Light Guide End Cap	White	20/bag	
GEXNLGC15	Tetra Contour Light Guide Connector	White	20/bag	
GEXNLGI15	Tetra Contour Light Guide 90° Inside Corner	White	20/bag	
GEXNLGO15	Tetra Contour Light Guide 90° Outside Corner	White	20/bag	
GEXNLGP15	Tetra Contour Light Guide 90° Planar Corner	White	20/bag	



GE Lighting • 1-888-MY-GE-LED (1-888-69-43-5333) • www.gelighting.com

GE Lighting Solutions, LLC. is a subsidiary of the General Electric Company. Tetra is a trademark of GE Lighting. The GE brand and logo are trademarks of the General Electric Company. © 2014 GE Lighting Solutions, LLC. Information provided is subject to change without notice. All values are design or typical values when measured under laboratory conditions.