

Product Description:

- Constant voltage LED power supply
- Universal input voltage range
- Constant output voltage
- Connection cable with stripped cable end (length approx. 350 mm)
- Failure rate at 0.27% per 1000 hours
- Polarity identifiers, secondary + red / - black
- Color white
- Nominal lifetime >70,000 h (at 230Vac, full load, Tc: 80°C)
- 7-year guarantee (for Tc: 80°C)
- Suitable for emergency installation according EN 50172



Properties:

- Small design
- Low power loss
- Short-circuit shutdown feature w/automatic restart
- OVP, OCP, OTP and Surge protection
- SELV
- Type of protection: IP68
- Metal casing, encapsulated, painting white



ORDERING GUIDE

Type	PS12-20W-GN
Article Number	28000507A
Packaging Carton	30 pc(s).
Package Dimensions (L x W x L)	7.09 x 2.95 x 1.18 in. (180 x 75 x 30 mm)
Weight per pc.	0.99 lb (0.45 kg)
Carton Dimensions (L x W x L)	15.35 x 14.76 x 4.33 in. (390 x 375 x 110 mm)
Carton Weight	33.1 lb (15 kg)

SPECIFIC TECHNICAL DATA

Type	PS12-20W-GN
Max. Casing Temp T _c	194° F (90° C)
Output Voltage	12.6 V
Max. Input Power	30 W
Output Current Range	0-1.67 A
Max. Output Voltage	13.2 V

STANDARD COMPLIANCE

Safety	Safety Standards
Certifications	UL879, CLASS2, CE, RoHS, FCC, MM

TECHNICAL DATA

Rated Supply Voltage	100-277 VAC
Input Voltage, AC	90-305 VAC
Input Voltage, DC	200-240 VDC
Max input current	0.3 A @ 100 VAC
Mains Frequency	47 - 63 Hz
Efficiency (at 230 V, 50 Hz, full load)	85%
λ (at 230 V, 50 Hz, full load)	> 0.90
THD	< 20%
Output Voltage Tolerance	-0 / +5 %
Output Power (T _a ≤ 60° C)	20 W
Output Power Range	0 - 20 W
No Load Power	> 0.5 W
Inrush Current	40 A
Turn On Time (Output)	≤ 0.5 s
Hold on Time at Power Failure (Output)	10 ms
Ambient Temperature T _a	-40° — +140° F (-40 ~ +60° C)
Storage Temperature T _s	-40° — +176° F (-40 ~ +80° C)
Dimensions (L x W x H)	5.67 x 1.65 x 0.9 in. (144 x 42 x 23 mm)

DIMENSIONS

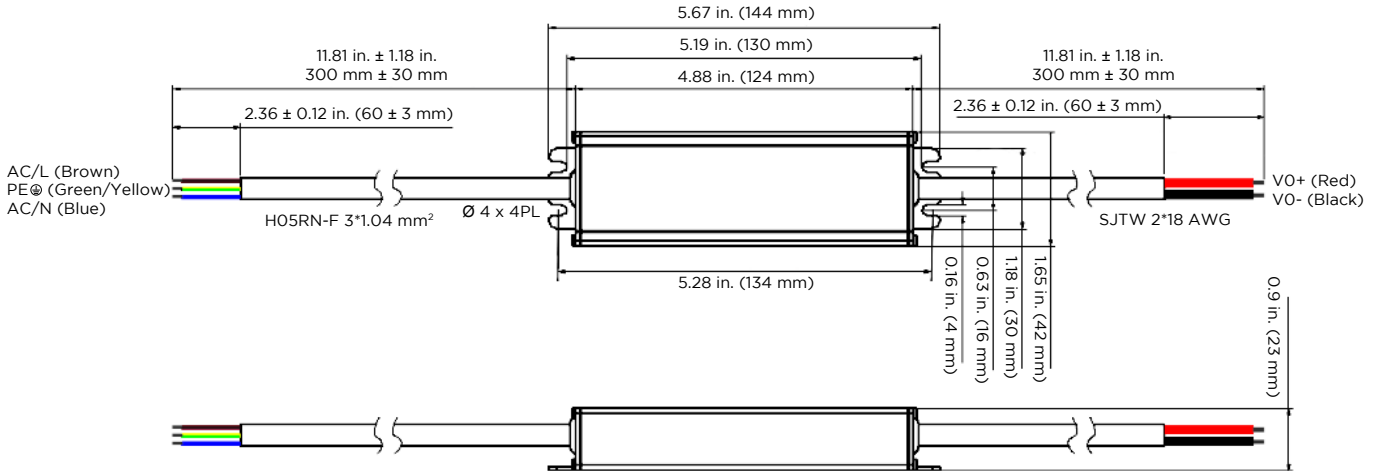

Note: To prevent exposure to the maximum allowable temperatures for these drivers, the suggested installation spacing between drivers is at least 4 in. (100 mm) side-to-side when the distance to the sidewall and top of the enclosure is 2 in. (50 mm). When the distance to the sidewall and top of the enclosure is 6 in. (150 mm), maintain at least 2 in. (100 mm) side-to-side spacing between drivers. Drivers should be placed a minimum of 1 in. (25 mm) apart when arranging them end-to-end regardless of the enclosure size.

CONNECTION

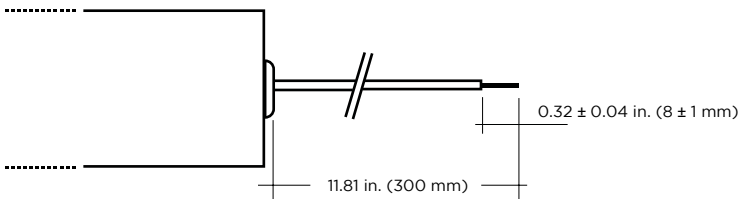

WIRING DIAGRAM

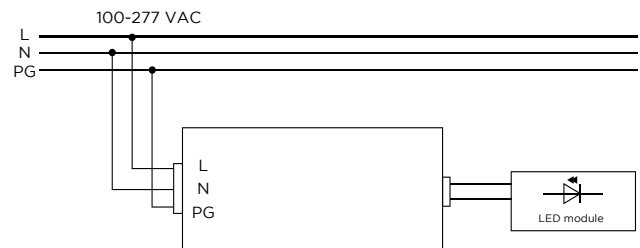

Primary Cable			Secondary Cable	
L	N	PG	+	-
brown	blue	green/yellow	red	black



PERFORMANCE CURVE

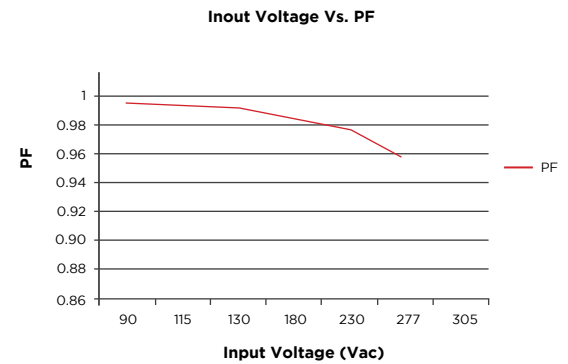
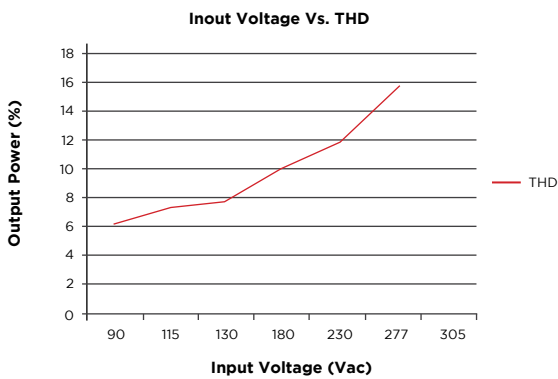
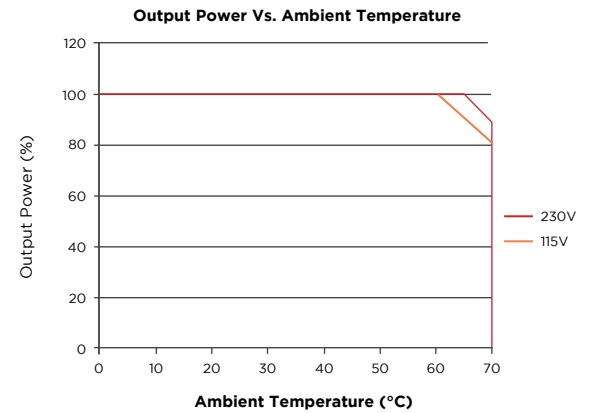
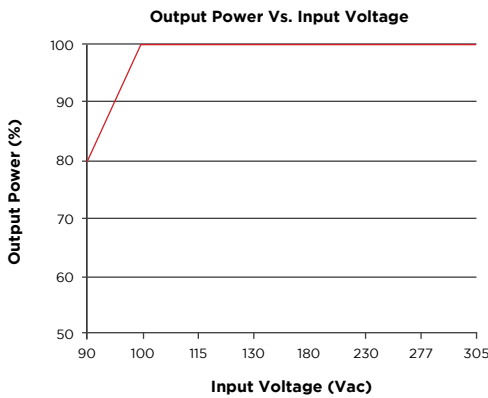
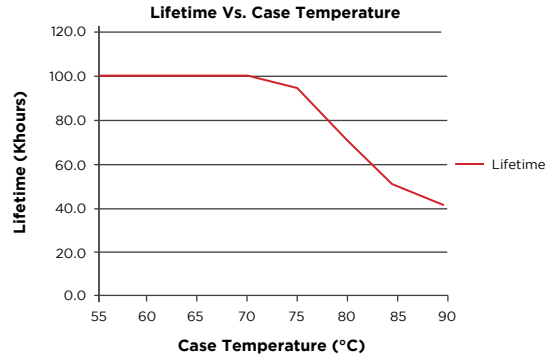
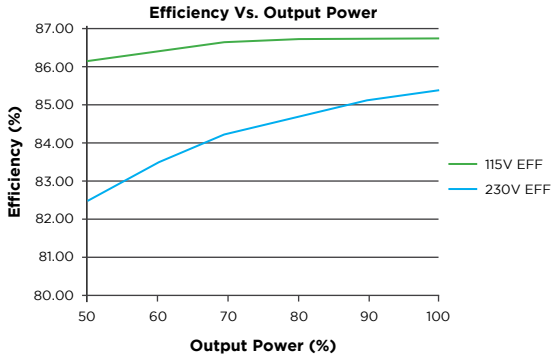

1. The maximum case temperature Tc shall not exceed 194°F (90°C) when used in end product.
2. These products are intended to be connected to a max. 20 A branch circuit.
3. These products are intended for use in dry and damp locations.
4. **Required spacing between power supply according to UL48.**