

DER Fachbetrieb für **Signage-LED**



Gesamtbroschüre für
RGB / RGBW / RGBA LED-Module



Beschreibung

Das neue mit drei SMS5050 hochwertigen LED's bestückte M-LED 3 RGB (Farbwechsel) ist ein Modul zur Akzent-/architektonischen Ausleuchtung von Konturen bzw. zur Hinterleuchtung von Einzelbuchstaben, Leuchtkästen sowie Spanntuchanlagen ab einer Bautiefe von 80 mm.

Dank der optischen Linse mit 160° Grad Abstrahlwinkel ist es möglich eine gleichmäßige Ausleuchtung auch mit größeren Modul- und Reihenabständen in der Werbeanlage zu realisieren. Möglich ist die LED-Module mit bis zu 200 mm Modulabstand (CC) anzuordnen, dies spart Kosten und Arbeitsaufwand. Das LED-Modul M-LED 3 RGB hat eine Leistung von 0,72W und emittiert 50.

Durch die Schutzart IP67 eignet sich das LED-Modul für den Einsatz sowohl im Innen- als auch im Außenbereich. Die Kette umfasst 25 Module, diese sind in dieser Anzahl maximal hintereinander in Serie anzuschließen.

Technische Spezifikationen

BETRIEBSSPANNUNG	12 VDC
LEISTUNG	0,72 W
EINBAUTIEFE	ab 80 mm
MODULABSTAND (CC)	200 mm
ABSTRAHLWINKEL	160° Grad
BINNING	3 SDCM
BETRIEBSTEMPERATUR	-25 °C ~ +60 °C
LAGERTERMPERATUR	-25 °C ~ +70 °C
NORMEN	UL,CE und RoHS
SCHUTZART	IP67
HERSTELLERGARANTIE	5 Jahre



CE RoHS cULus

max. 25 Module in Reihe anschließen

Anwendung

Akzent-/architektonische Ausleuchtung von Konturen, Einzelbuchstaben, Leuchtkästen und Spanntuchanlagen ab einer Bautiefe von 80 mm mit Farbwechsel

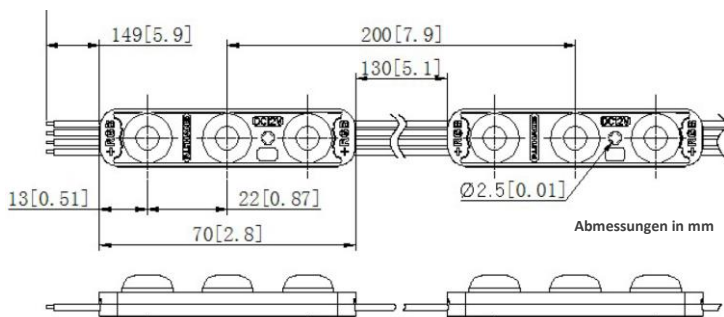

Besonderheiten

- 200 mm Modulabstand (CC)
- Schutzart IP67
- 5 Jahre Herstellergarantie
- Einfache Installation & Handhabung

Verpackung

Module/Kette	Module/Beutel	Module/Karton
25 Module	2 Ketten / 50 Module	10 Beutel / 500 Module

Beschreibung

Das neue mit drei SMS5050 hochwertigen LED's bestückte M-LED 3 RGBW (Farbwechsel inkl. Weiß 6500K) ist ein Modul zur Akzent-/architektonischen Ausleuchtung von Konturen bzw. zur Hinterleuchtung von Einzelbuchstaben, Leuchtkästen sowie Spanntuchanlagen ab einer Bautiefe von 80 mm.

Dank der optischen Linse mit 160° Grad Abstrahlwinkel ist es möglich eine gleichmäßige Ausleuchtung auch mit größeren Modul- und Reihenabständen in der Werbeanlage zu realisieren. Möglich ist die LED-Module mit bis zu 175 mm Modulabstand (CC) anzuordnen, dies spart Kosten und Arbeitsaufwand. Das LED-Modul M-LED 3 RGBW hat eine Leistung von 1W und emittiert 55.

Durch die Schutzart IP65 eignet sich das LED-Modul für den Einsatz sowohl im Innen- als auch im Außenbereich. Die Kette umfasst 20 Module, diese sind in dieser Anzahl maximal hintereinander in Serie anzuschließen.

Technische Spezifikationen

BETRIEBSSPANNUNG	12 VDC
LEISTUNG	1 W
EINBAUTIEFE	ab 80 mm
MODULABSTAND (CC)	175 mm
ABSTRAHLWINKEL	160° Grad
BINNING	3 SDCM
BETRIEBSTEMPERATUR	-25 °C ~ +60 °C
LAGERTERMPERATUR	-25 °C ~ +70 °C
NORMEN	UL, CE und RoHS
SCHUTZART	IP65
HERSTELLERGARANTIE	5 Jahre



CE RoHS eTV us

max. 25 Module in Reihe anschließen

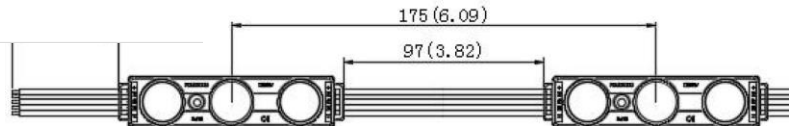

Anwendung

Akzent-/architektonische Ausleuchtung von Konturen, Einzelbuchstaben, Leuchtkästen und Spanntuchanlagen ab einer Bautiefe von 80 mm mit Farbwechsel

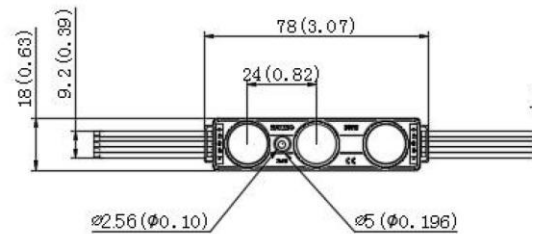

Abmessungen in mm

Besonderheiten

- 175 mm Modulabstand (CC)
- Schutzart IP65
- 5 Jahre Herstellergarantie
- Einfache Installation & Handhabung

Verpackung

Module/Kette	Module/Beutel	Module/Karton
20 Module	2 Ketten / 40 Module	16 Beutel / 640 Module

ULTRA 650 RGBA

ULTRA 650 RGBA modules are premium color changing signage modules engineered for constant current so there is no lumen drop across the full length of any string. The ULTRA 650 RGBA module features four chips in each LED - red, green, blue and amber for added warmth. Use DMX controls to tune ULTRA 650 RGBA modules to any color.

Applications:

- Channel letters
- Box signs
- Cove lighting
- Applications starting at depths of 3 in. (75 mm)











UL LISTED CE RoHS IP66



ORDERING GUIDE

Part Number	White Color Temperatures & Colors	LEDs per Module	Module Spacing (mm)	Number of Modules		Nominal Light Output (lm)		
				Per Foot	Per Meter	Per Module	Per Foot	Per Meter
LS-U650-RGBA-B200-A	All	3	200	1.5	5	50.3	76.7	251.5
	Red (617 - 633 nm)	3	200	1.5	5	10.8	16.5	54
	Green (517 - 533 nm)	3	200	1.5	5	25.5	38.9	127.5
	Blue (457 - 473 nm)	3	200	1.5	5	5.2	7.9	26
	Amber (602 - 618 nm)	3	200	1.5	5	8.8	13.4	44

RECOMMENDED CONTROL OPTIONS

Options	Image	Description	Part Number
1 For basic setting		4 Zone Color Changing Glass Touch Wall Controller	AWCRGBWWBK
		5 Channel DMX Interface	DMXINFLCD5
2 For wireless connection		4 Channel RF Interface	RFINTERFACE4CH
		4 Zone RGBW RF Remote	RFREMOTERGBW4Z
		RF to WiFi Converter	RFWIFICONVERT
3 For advanced setting		4 Channel Waterproof DMX LCD Interface	DMXINFWLCD4
		5 Zone DMX Wall Controller	DMXCTRL
		10 Zone DMX Wall Controller	DMXCTRLD

LUMINOUS DISTRIBUTION

Batwing Beam Pattern

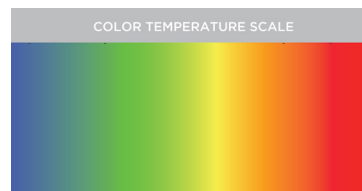
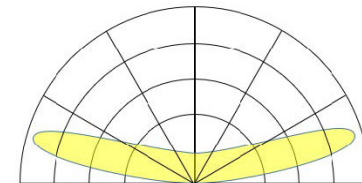

PRODUCT RATINGS

Luminous Efficacy	41.9 lm/W (All) 36 lm/W (Red) 85 lm/W (Green) 17.3 lm/W (Blue) 29.3 lm/W (Amber)	Input Current	100 mA (All) 25 mA (Red) 25 mA (Green) 25 mA (Blue) 25 mA (Amber)
Wattage per Module	1.20 W/module (All) 0.30 W/module (Red) 0.30 W/module (Green) 0.30 W/module (Blue) 0.30 W/module (Amber)	Power Supply Loading	46 modules per 60 W
Input Voltage	12 V DC	Ingress Protection	IP66
		Operating Temperature	-13° - +131°F (-25° - +55°C)
		L70 Lifetime @ 60° C	50,000 hours
		Warranty	5 Year Limited Warranty

MODULE DIMENSIONS

Part Number	Length (in. / mm)	Width (in. / mm)	Height (in. / mm)
LS-U650-RGBA-B200-A	2.62 / 66	0.61 / 15	0.38 / 10

POWER SUPPLY LOADING

Module Type	Per 60W Power Supply			
	Max. # of Modules Per String	Total # of Modules	Total # of Feet	Total # of Meters
LS-U650-RGBA-B200-A	44	46	30.7	9.3

LAYOUT GUIDE

Channel Depth (in.)	Single Row		Multiple Rows		Channel Depth (mm)	Single Row		Multiple Rows	
	Max. Stroke	Module Spacing	Row Spacing	Module Spacing		Max. Stroke	Module Spacing	Row Spacing	Module Spacing
3	6	5	4	4	75	150	125	100	100
4	9	6	6	7	100	225	150	150	175
5	12	8	10	8	125	300	200	250	200
6	14	8	12	8	150	350	200	300	200

*Module spacing is defined by 7328 white sign face material

SHIPPING INFORMATION

Module Type	Specs	Packaging Quantity			Carton Weight	Carton Dimensions			Box Weight	Box Dimensions			
		Per Bag	Per Box	Per Carton		L	W	H		L	W	H	
LS-U650-RGBA-B200-A	Modules	100	600	1000	18.5 kg (40.7 lbs)	20.5	14.6	10.2	9 kg (19.8 lbs)	13.78	9.84	9.06	in.
	Feet	65.6	328.1	656.2						350	250	230	mm
	Meters	20	100	200									

DIMENSION DRAWING

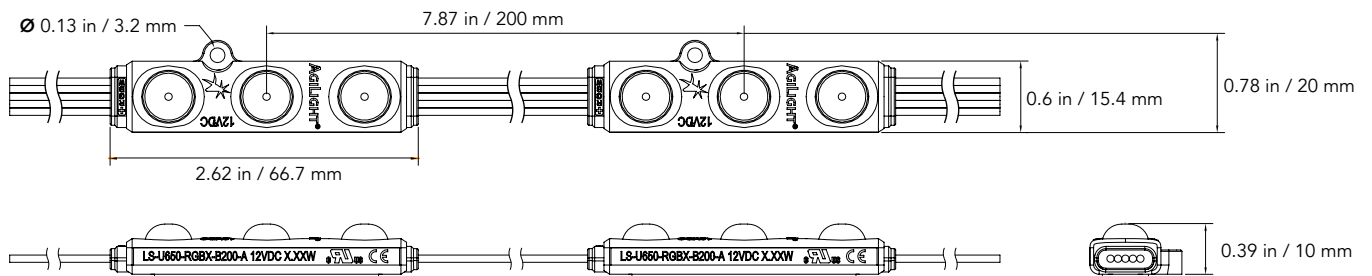

1. UL ONLY - These products are only suitable for connection to a UL rated Class 2 power source rated 12 Volt or less.
2. UL ONLY - These products are intended for use only when connected to a power source that complies with UL rated Class 2 voltage and energy limited circuit.
3. UL ONLY - When these units are connected to a UL rated Class 2 circuit, they are not to draw a total wattage of greater than the secondary or output rating of the UL rated Class 2 power supply.
4. These products may be secured in place in the end product by any means available.
5. These products are suitable for use in dry, damp, and wet locations. Not suitable for submersed applications.

ULTRA 650 RGBW

ULTRA 650 RGBW modules are premium color changing signage modules engineered for constant current so there is no lumen drop across the full length of any string. The ULTRA 650 RGBW module features four chips in each LED - red, green, blue and white for added brightness. Use DMX controls to tune ULTRA 650 RGBW modules to any color.

Applications:

- Channel letters
- Box signs
- Cove lighting
- Applications starting at depths of 3 in. (75 mm)



ORDERING GUIDE

Part Number	White Color Temperatures & Colors	LEDs per Module	Module Spacing (mm)	Number of Modules		Nominal Light Output (lm)		
				Per Foot	Per Meter	Per Module	Per Foot	Per Meter
LS-U650-RGBW-B200-A	All	3	200	1.5	5	62.6	95.4	313
	Red (612 - 628 nm)	3	200	1.5	5	7.6	11.6	38
	Green (512 - 528 nm)	3	200	1.5	5	18.5	28.2	92.5
	Blue (457 - 473 nm)	3	200	1.5	5	6	9.1	30
	White (6500K)	3	200	1.5	5	30.5	46.5	152.5

RECOMMENDED CONTROL OPTIONS

Options	Image	Description	Part Number
1 For basic setting		4 Zone Color Changing Glass Touch Wall Controller	AWCRGBWWBK
		5 Channel DMX Interface	DMXINFLCD5
2 For wireless connection		4 Channel RF Interface	RFINTERFACE4CH
		4 Zone RGBW RF Remote	RFREMOTERGBW4Z
		RF to WiFi Converter	RFWIFICONVERT
3 For advanced setting		4 Channel Waterproof DMX LCD Interface	DMXINFWLCD4
		5 Zone DMX Wall Controller	DMXCTRL
		10 Zone DMX Wall Controller	DMXCTRLD

LUMINOUS DISTRIBUTION

Batwing Beam Pattern

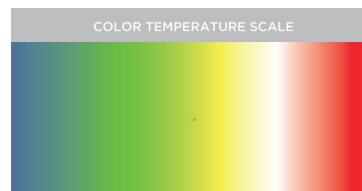
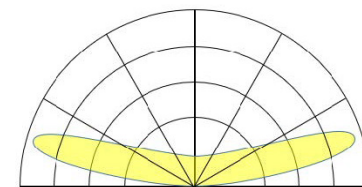

PRODUCT RATINGS

Luminous Efficacy	52.2 lm/W (All) 25.3 lm/W (Red) 61.7 lm/W (Green) 20 lm/W (Blue) 101.7 lm/W (White)	Input Current	100 mA (All) 25 mA (Red) 25 mA (Green) 25 mA (Blue) 25 mA (White)
Wattage per Module	1.20 W/module (All) 0.30 W/module (Red) 0.30 W/module (Green) 0.30 W/module (Blue) 0.30 W/module (White)	Power Supply Loading	46 modules per 60 W
Input Voltage	12 V DC	Ingress Protection	IP66
		Operating Temperature	-13° - +131°F (-25° - +55°C)
		L70 Lifetime @ 60° C	50,000 hours
		Warranty	5 Year Limited Warranty

MODULE DIMENSIONS

Part Number	Length (in. / mm)	Width (in. / mm)	Height (in. / mm)
LS-U650-RGBW-B200-A	2.62 / 66	0.61 / 15	0.38 / 10

POWER SUPPLY LOADING

Module Type	Per 60W Power Supply			
	Max. # of Modules Per String	Total # of Modules	Total # of Feet	Total # of Meters
LS-U650-RGBW-B200-A	44	46	30.7	9.3

LAYOUT GUIDE

Channel Depth (in.)	Single Row		Multiple Rows		Channel Depth (mm)	Single Row		Multiple Rows	
	Max. Stroke	Module Spacing	Row Spacing	Module Spacing		Max. Stroke	Module Spacing	Row Spacing	Module Spacing
3	6	5	4	4	75	150	125	100	100
4	9	6	6	7	100	225	150	150	175
5	12	8	10	8	125	300	200	250	200
6	14	8	12	8	150	350	200	300	200

*Module spacing is defined by 7328 white sign face material

SHIPPING INFORMATION

Module Type	Specs	Packaging Quantity			Carton Weight	Carton Dimensions			Box Weight	Box Dimensions			
		Per Bag	Per Box	Per Carton		L	W	H		L	W	H	
LS-U650-RGBW-B200-A	Modules	100	600	1000	18.5 kg (40.7 lbs)	20.5	14.6	10.2	9 kg (19.8 lbs)	13.78	9.84	9.06	in.
	Feet	65.6	328.1	656.2		520	370	260		350	250	230	mm
	Meters	20	100	200									

DIMENSION DRAWING

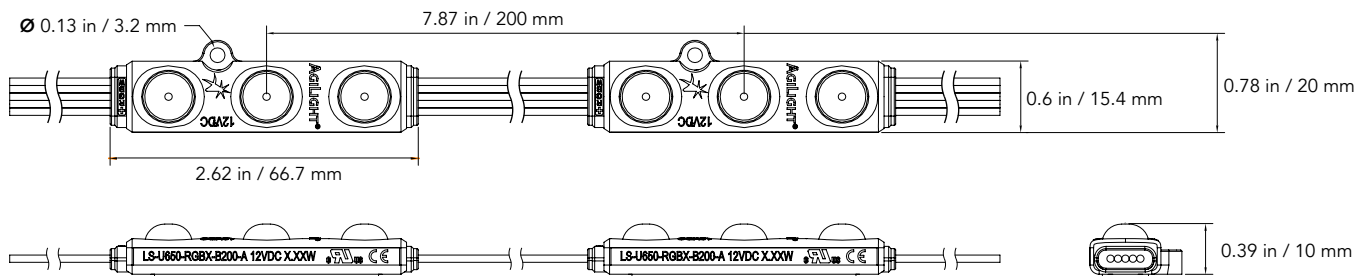

1. UL ONLY - These products are only suitable for connection to a UL rated Class 2 power source rated 12 Volt or less.
2. UL ONLY - These products are intended for use only when connected to a power source that complies with UL rated Class 2 voltage and energy limited circuit.
3. UL ONLY -When these units are connected to a UL rated Class 2 circuit, they are not to draw a total wattage of greater than the secondary or output rating of the UL rated Class 2 power supply.
4. These products may be secured in place in the end product by any means available.
5. These products are suitable for use in dry, damp, and wet locations. Not suitable for submersed applications.



malux
Innovative Lichttechnik

KONTAKT



(06423) 544 60-0



Sandhute 7
35094 Lahntal



info@malux.de



www.malux.de



Folgen Sie uns auch auf
Instagram: @maluxgmbh