



LYTERAYZ[®] SERIES

The LRZ3 RGB module is part of our LyteRayz value line series. Each string of triple-LED LRZ3 modules can light your signs in red, green, blue or any blended color combination. Great for channel letters, box signs and cove lighting, the LRZ3 RGB comes with an IP66 rating and a five-year warranty.

Applications:

- Channel letters
- Box signs
- Cove lighting
- Applications starting at 3" (75 mm) depth



12V DC



5 YEAR LIMITED WARRANTY



50,000 HRS
L70 LIFETIME

ORDERING GUIDE

Part Number	White Color Temperatures & Colors	LEDs per Module	Module Spacing (mm)	Number of Modules		Nominal Light Output (lm)*		
				Per Foot	Per Meter	Per Module	Per Foot	Per Meter
LS-LRZ3-RGB-B200-A	All	3	200	1.5	5	29	43.5	145
	Red (620-625nm)	3	200	1.5	5	8	12	40
	Green (520-525nm)	3	200	1.5	5	16	24	80
	Blue (460-470nm)	3	200	1.5	5	5	7.5	25

PRODUCT RATINGS

Luminous Efficacy	29 lm/W (All) 8 lm/W (Red) 16 lm/W (Green) 5 lm/W (Blue)
Wattage per Module	0.72 W/module (All) 0.24 W/module (Red) 0.24 W/module (Green) 0.24 W/module (Blue)
Input Voltage	12 V DC
Input Current	60 mA (All) 20 mA (Red) 20 mA (Green) 20 mA (Blue)
Power Supply Loading	83 modules per 60W
Ingress Protection	IP66
Operating Temperature	-13° - +131° F (-25° - +55° C)
L70 Lifetime @ 60° C	50,000 Hours
Warranty	5 Year Limited Warranty

LUMINOUS INTENSITY DISTRIBUTION

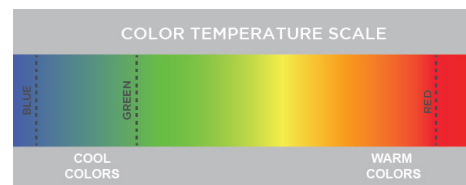
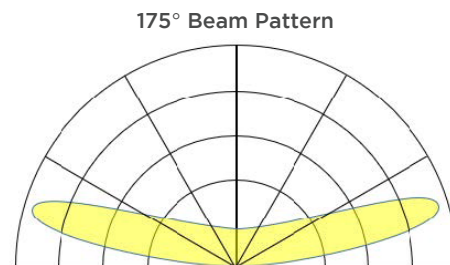

MODULE DIMENSIONS

Part Number	Length (in./mm)	Width (in./mm)	Height (in./mm)
LS-LRZ3-RGB-B200-A	2.62/66	0.61/15	0.38/10



POWER SUPPLY LOADING

Module Type	Per 60W Power Supply			
	Max. # of Modules Per String	Total # of Modules	Total # of Feet	Total # of Meters
LS-LRZ3-RGB-B200-A	20	83	54.5	16.6

LAYOUT GUIDE*

Channel Depth (in.)	Single Row		Multiple Rows		Channel Depth (mm)	Single Row		Multiple Rows	
	Max. Stroke	Module Spacing	Row Spacing	Module Spacing		Max. Stroke	Module Spacing	Row Spacing	Module Spacing
3	6	5	4	4	75	150	125	100	100
4	9	6	6	7	100	225	150	150	175
5	12	8	10	8	125	300	200	250	200
6	14	8	12	8	150	350	200	300	200

*Module spacing is defined by 7328 white sign face material

SHIPPING INFORMATION

Module Type	Specs	Packaging Quantity		
		Per Bag	Per Box	Per Carton
LS-LRZ3-RGB-B200-A	Modules	100	500	1000
	Feet	65.6	328.1	656.2
	Meters	20	100	200

Carton Dimensions			Carton Weight	Box Dimensions			Box Weight
L	W	H		L	W	H	
20.5	14.6	10.2	18.5 kg (40.7 lbs)	12.2	9.06	2.56	9 kg (19.8 lbs) in.
520	370	260		310	230	65	mm

DIMENSION DRAWING

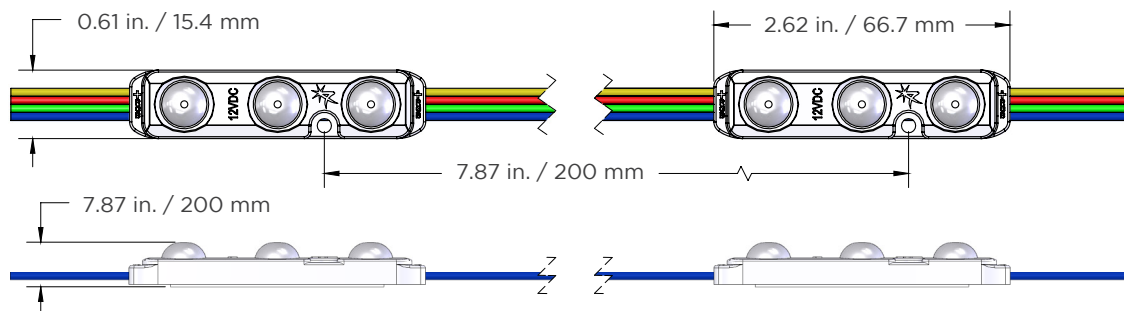

1. UL ONLY - These products are only suitable for connection to a UL rated Class 2 power source rated 12 Volt or less.
2. UL ONLY - These products are intended for use only when connected to a power source that complies with UL rated Class 2 voltage and energy limited circuit.
3. UL ONLY - When these units are connected to a UL rated Class 2 circuit, they are not to draw a total wattage of greater than the secondary or output rating of the UL rated Class 2 power supply.
4. These products may be secured in place in the end product by any means available.
5. These products are suitable for use in dry and damp locations. Not suitable for wet or submersed applications.