

**Product Description:**

- Constant voltage LED power supply
- Universal input voltage range
- Constant output voltage
- Connection cable with stripped cable end (length approx. 350 mm)
- Failure rate at 0.37% per 1000 hours
- Polarity identifiers, secondary + red / - black
- Color white
- Nominal lifetime >70,000 h (at 230Vac, full load, Tc: 80°C)
- 7-year guarantee (for Tc: 80°C)
- Suitable for emergency installation according EN 50172

**Properties:**

- Small design
- Low power loss
- Short-circuit shutdown feature w/automatic restart
- OVP, OCP, OTP and surge protection
- SELV
- Type of protection: IP68
- Metal casing, encapsulated, painting white



**ORDERING GUIDE**

Type	PS24-100W-GN
Article Number	28000513A
Packaging Carton	12 pc(s).
Package Dimensions (L x W x L)	10.24 x 3.94 x 1.77 in. (260 x 100 x 45 mm)
Weight per pc.	1.98 lb (0.9 kg)
Carton Dimensions (L x W x L)	16.34 x 11.02 x 6.3 in. (415 x 280 x 160 mm)
Carton Weight	26.01 lb (11.8 kg)

**SPECIFIC TECHNICAL DATA**

Type	PS24-100W-GN
Max. Casing Temp T <sub>c</sub>	194° F (90° C)
Output Voltage	24.7 V
Max. Input Power	160 W
Output Current Range	0-4.16 A
Max. Output Voltage	24.94 V

**STANDARD COMPLIANCE**

Safety	Safety Standards
Certifications	UL879, CLASS 2, CE, RoHS, FCC, MM

**TECHNICAL DATA**

Rated Supply Voltage	100-277 VAC
Input Voltage, AC	90-305 VAC
Input Voltage, DC	200-240 VDC
Max input current	1.6 A @ 100 VAC
Mains Frequency	47 - 63 Hz
Efficiency (at 230 V, 50 Hz, full load)	> 85%
λ (at 230 V, 50 Hz, full load)	> 0.90
THD	< 20%
Output Voltage Tolerance	240 mV
Output Power (T <sub>a</sub> ≤ 60° C)	100 W
Output Power Range	0 - 100 W
No Load Power	> 0.5 W
Inrush Current	< 50 A
Turn On Time (Output)	≤ 0.3 s
Hold on Time at Power Failure (Output)	10 ms
Ambient Temperature T <sub>a</sub>	-40° — +140° F (-40 ~ +60° C)
Storage Temperature T <sub>s</sub>	-40° — +176° F (-40 ~ +80° C)
Dimensions (L x W x H)	8.46 x 2.66 x 1.38 in. (215 x 67.5 x 35 mm)

**DIMENSION DRAWINGS**

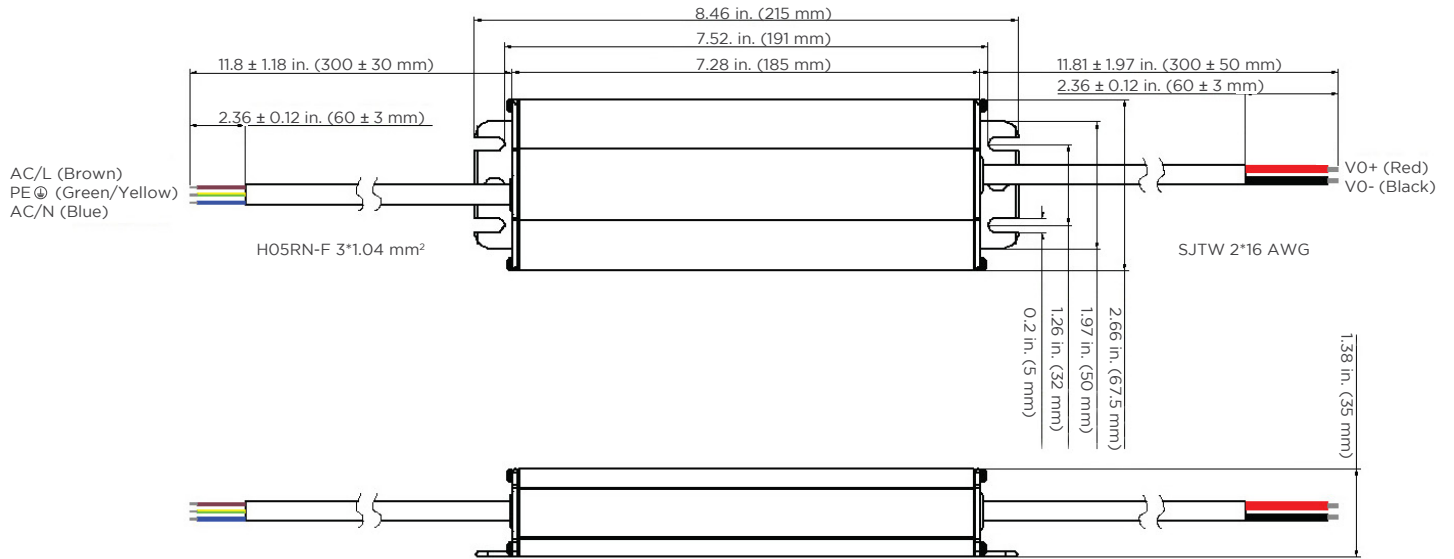

**Note:** To prevent exposure to the maximum allowable temperatures for these drivers, the suggested installation spacing between drivers is at least 4 in. (100 mm) side-to-side when the distance to the sidewall and top of the enclosure is 2 in. (50 mm). When the distance to the sidewall and top of the enclosure is 6 in. (150 mm), maintain at least 2 in. (100 mm) side-to-side spacing between drivers. Drivers should be placed a minimum of 1 in. (25 mm) apart when arranging them end-to-end regardless of the enclosure size.

**CONNECTION**

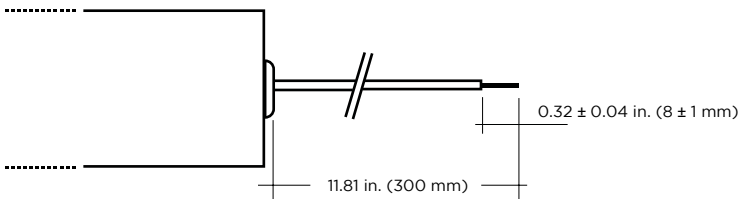

**WIRING DIAGRAM**

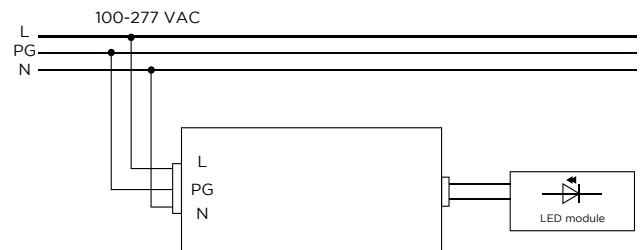

Primary Cable			Secondary Cable	
L	N	PG	+	-
brown	blue	green/yellow	red	black



**PERFORMANCE CURVE**

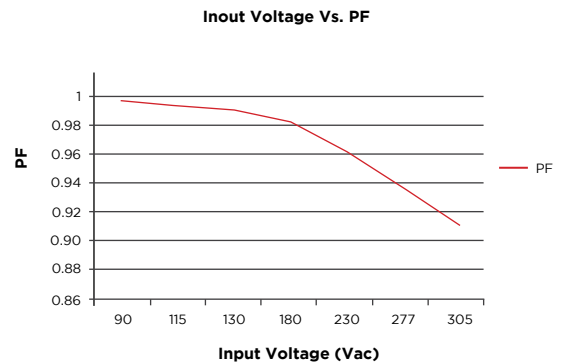
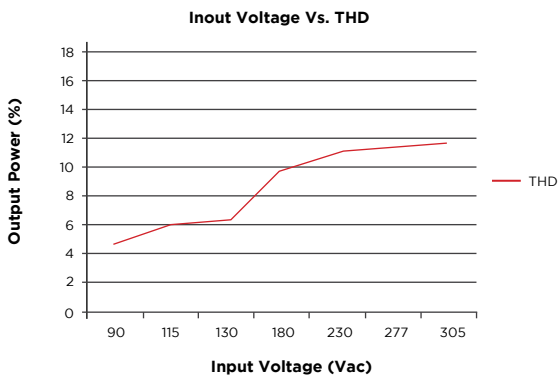
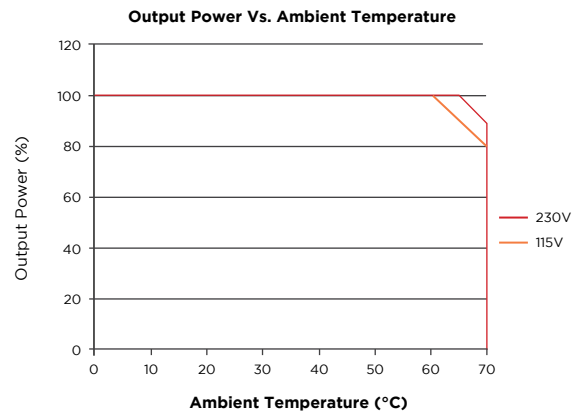
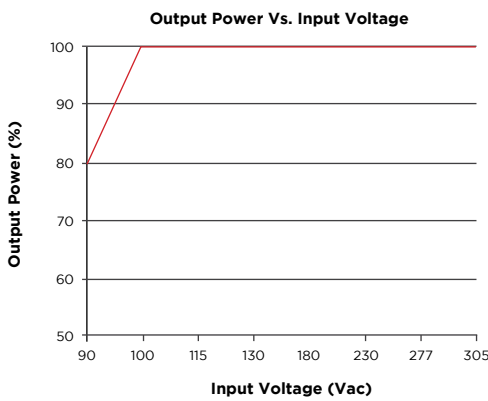
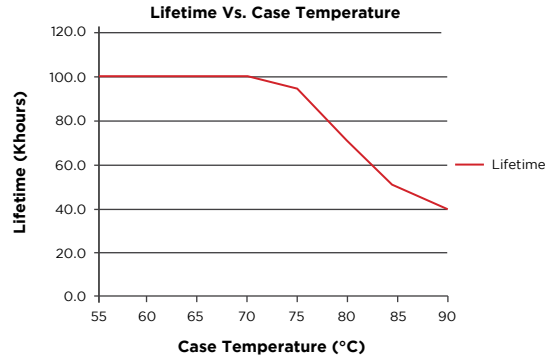
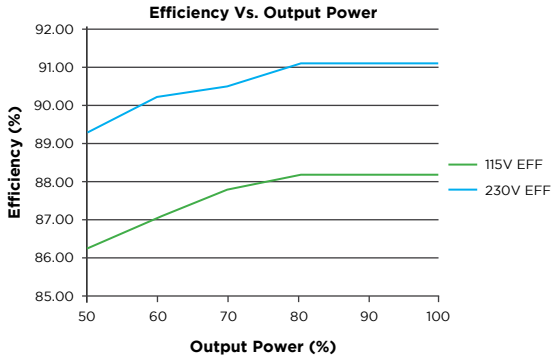

1. The maximum case temperature Tc shall not exceed 194°F (90°C) when used in end product.
2. These products are intended to be connected to a max. 20 A branch circuit.
3. These products are intended for use in dry and damp locations.
4. **Required spacing between power supply according to UL48.**